



Operation manual

GYRO STABILIZER

SG80

(en) English

Disclaimers:

All information, illustrations and specifications in this manual are based on the latest information available at the time of publishing. The illustrations used in this manual are intended to be representative reference views only. Moreover, because of our continuous product improvement policy, we may modify information, illustrations and/or specifications to explain and/or exemplify a product, service or maintenance improvement. We reserve the right to make any change at any time without notice. Smartgyro is a registered trademark of Smartgyro s.r.l. in the United States, the European Union, and the United Kingdom.

All Rights Reserved:

No part of this publication may be reproduced or used in any form by any means - graphic, electronic, or mechanical, including photocopying, recording, taping, or information storage and retrieval systems - without the written permission of Smartgyro s.r.l.

Please review and comply with the applicable laws and regulations of the international export control regimes at the territory or country where the product and manual are intended to be imported and used.

OPERATION MANUAL	MODEL	SG80
	CODE	108OM405

All Rights Reserved, Copyright Smartgyro s.r.l.

Content

Introduction	1
Safety	3
Safety symbols	3
Safety precautions	4
General information	4
Before you operate	4
During operation and maintenance	4
Product overview	8
Overview	8
System description	9
Function of Gyro Stabilizer	10
Component of SG80 Gyro Unit	11
Description of SG80 Gyro Unit	12
Description of control display	13
Home page	14
Setting the control display	18
Roll Angle Monitor Page	21
Alarm Log Page	22
Performance Monitor Page	24
Gyro stabilizer operation	26
Introduction	26
Safety precautions	26
Gyro Stabilizer Startup and Stabilization	27
Temperature derating	30
Gyro Stabilizer Shutdown	31
Emergency shutdown	32
Periodic maintenance	33
Introduction	33
Safety precautions	33
Precautions	34
Periodic maintenance schedule	35
Troubleshooting	38
Safety precautions	38
Troubleshooting information	38
Gyro system anomaly	39
Troubleshooting chart	40
Specifications	44
Introduction	44
SG80 Technical characteristics	45

Introduction

It isn't easy to outsmart the most powerful element on earth. In fact, it takes brazen courage. At Smartgyro, we push the limits of technology to elevate the entire boating experience. Our gyro stabilizers eliminate boat roll to make life's richest moments more extraordinary.

We believe the ultimate luxury is uninterrupted time on the water. That's why Smartgyro SG80 is designed to minimize not only unwanted movement but also downtime during maintenance. We are leading the way and raising the bar for onboard comfort, safety, reliability, and convenience.

To help you use your Smartgyro products for many years to come, please follow these recommendations:

- Read and understand this Operation Manual before you operate the gyro stabilizer to ensure that you follow safe operating practices and maintenance procedures.
- Keep this Operation Manual in a convenient place for easy access.
- If this Operation Manual is lost or damaged, order a new one from your authorized Smartgyro dealer or distributor.
- Make sure this manual is transferred to subsequent owners. This manual should be considered a permanent part of the gyro stabilizer and remain with it.
- Constant efforts are made to improve the quality and performance of Smartgyro products, so some details included in this Operation Manual may differ slightly from your gyro stabilizer. If you have any questions about these differences, please consult your authorized Smartgyro dealer or distributor.

Safety

Smartgyro SG80 considers safety of great importance and recommends that anyone that comes into close contact with its products, such as those who install, operate, maintain or service Smartgyro products, exercises care and common sense and complies with the safety information in this manual and on the machine's safety decals. Keep the labels from becoming dirty or torn and replace them if they are lost or damaged. Also, if you need to replace a part that has a label attached to it, make sure you order the new part and label at the same time.

Safety symbols

These are the warning signs used in this manual and on the product.



This safety alert symbol appears with most safety statements. It means "attention, become alert, your safety is involved!" Please read and abide by the message that follows the safety alert symbol.

DANGER

Indicates a hazardous situation which, if not avoided, will result in death or serious injury.

WARNING

Indicates a hazardous situation which, if not avoided, could result in death or serious injury.

CAUTION

Indicates a hazardous situation which, if not avoided, could result in minor or moderate injury.

NOTICE

Indicates a situation which can cause damage to the machine, personal property and/or the environment, or cause the equipment to operate improperly.

Safety precautions

General information

There is no substitute for common sense and careful practices. Improper practices or carelessness can cause burns, cuts, mutilation, asphyxiation, other bodily injury or death. This information contains general safety precautions and guidelines that must be followed to reduce risk to personal safety. Special safety precautions are listed in specific procedures. Read and understand all of the safety precautions before operation or performing repairs or maintenance.

Before you operate



The safety messages that follow have DANGER level hazards.



Never permit anyone to perform maintenance or operate the gyro stabilizer without proper training.

- Read and understand this Operation Manual before you operate or service the gyro stabilizer to ensure that you follow safe operating practices and maintenance procedures.
- Safety signs and labels are additional reminders for safe operating and maintenance techniques.
- Consult an authorized Smartgyro dealer or distributor for additional training.

During operation and maintenance



The safety messages that follow have WARNING level hazards.

Explosion Hazard



Keep flammable materials such as gasoline out of the area where the gyro stabilizer is installed.

Before operating the gyro stabilizer, confirm that there are no flammable materials such as gasoline around the gyro stabilizer.

Fire Hazard



Undersized wiring systems can cause an electrical fire.

Sever Hazard



The gyro stabilizer may potentially cause mechanical and electrical hazards. For this reason, never stay in close proximity to the gyro unit, and never service it when electrical power is applied or when the flywheel is running.

⚠ WARNING

- Never remove the protection panels that cover the gyro unit when the gyro stabilizer is running.
- Maintenance activities must always be performed by qualified technicians only when power is disconnected and the flywheel is stopped.

Alcohol and Drug Hazard

Never service the gyro stabilizer while under the influence of alcohol or drugs, or when feeling ill.

Exposure Hazard

Always wear personal protective equipment including appropriate clothing, gloves, work shoes, and eye and hearing protection as required by the task at hand.

⚠ WARNING**Entanglement Hazard**

When servicing the gyro stabilizer, make sure that the gyro system is not powered. It is possible for someone to activate the gyro system without realizing that someone is working on the gyro unit.

Never operate or service the gyro stabilizer while wearing a headset to listen to music or the radio because it will be difficult to hear the warning signals.

Burn Hazard

Some of the gyro unit surfaces can become very hot during operation and shortly after shut-down. Keep your hands and other body parts

WARNING**Electrical Shock Hazard**

- Inside the gyro unit hazardous voltages are present. For this reason the cover must not be opened when the gyro system is running and AC power is connected. Also, never disconnect the yellow/green earthing/grounding cable, connected to the ground stud.
- Before opening the cover be sure that the AC mains supply is disconnected from the gyro unit.
- Before operating the gyro stabilizer ALWAYS ensure that the safety ground cable is securely connected to the gyro base frame.
- The inverter box contains hazardous voltages derived from the AC power line. When inspecting the inside of the inverter box, be sure to turn off the AC power supply.
- A potentially dangerous voltage is present even if AC power is disconnected but the flywheel is still rotating. Therefore, service work on the inverter box is only permitted when power is disconnected and the flywheel has come to a complete stop.

CAUTION**Poor Lighting Hazard**

Ensure that the work area is adequately illuminated. Always install wire cages on portable safety lamps.

Tool Hazard

Always use tools appropriate for the task at hand and use the correct size tool for loosening or tightening machine parts.

Flying Object Hazard

Always wear eye protection when servicing the gyro stabilizer or when using compressed air or high-pressure water. Dust, flying debris, compressed air, pressurized water or steam may injure your eyes.

Coolant Hazard

Wear eye protection and rubber gloves when you handle coolant or hydraulic oil. If contact with your eyes or skin occurs, clean and wash it off immediately with clean water.

NOTICE

The safety messages that follow have NOTICE level hazards.

Periodic maintenance prevents unexpected downtime and helps extend the life of the gyro stabilizer.



Always be environmentally responsible.

Follow the guidelines of the EPA or other governmental agencies for the proper disposal of hazardous materials such as coolant and hydraulic oil. Consult the local authorities or reclamation facility.

Never dispose of hazardous materials by dumping them into a sewer, on the ground, or into groundwater or waterways.

Do not shut off the power or short the cables while the gyro system is running. Damage to the electrical system will result.

Product overview

Overview

Smartgyro SG80 is the gyro stabilizer of choice for boats from 60–70 ft.

Ideal for both new builds and refit installations, the stabilizer can be fully serviced on-board the vessel without the need to lift it out for maintenance, ensuring significant savings in time and cost.

For larger vessels, in order to increase the anti-roll torque, more than one Smartgyro SG80 can operate in parallel on the same boat. These units work autonomously and there is no need to synchronize them.

This manual, therefore, only outlines a single unit installation, where the gyro stabilizer is controlled by its own control device (the “Control display”).

System description

This gyro stabilizer contains the following units.

- SG80 gyro unit
- Control display

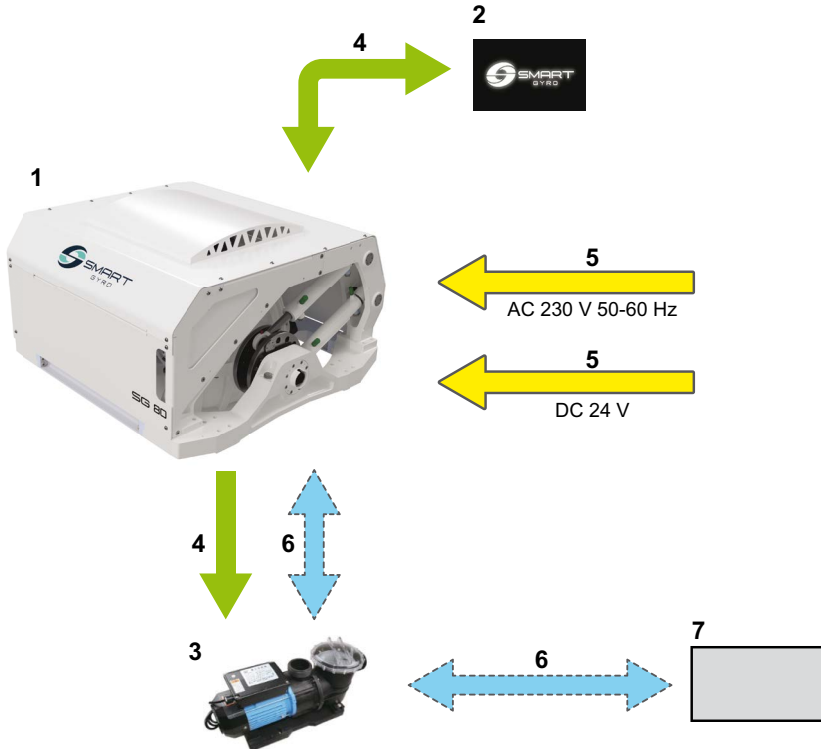

Figure 1

- | | |
|---|---|
| <ul style="list-style-type: none"> 1. SG80 gyro unit 2. Control display 3. See water pump *1 4. Electrical connections (electronic control) | <ul style="list-style-type: none"> 5. Electrical connections (power) 6. Hydraulic connections *1 7. Sea water intake |
|---|---|

*1. Item not included in the scope of supply.

Function of Gyro Stabilizer

This gyro stabilizer is a device that creates an anti-roll torque that reduces the tilting of the boat using the gyroscopic principle.

Anti-roll torque is generated by the combined effect of having a high-inertia flywheel rotating inside the gyro sphere and the sphere

tilting around the precession axis. The precession movement is automatically created by the gyro, when subjected to the sea roll, and is dynamically adjusted by the control unit, that regulates the braking effect of two hydraulic cylinders, to transmit the optimal anti-roll torque to the boat.

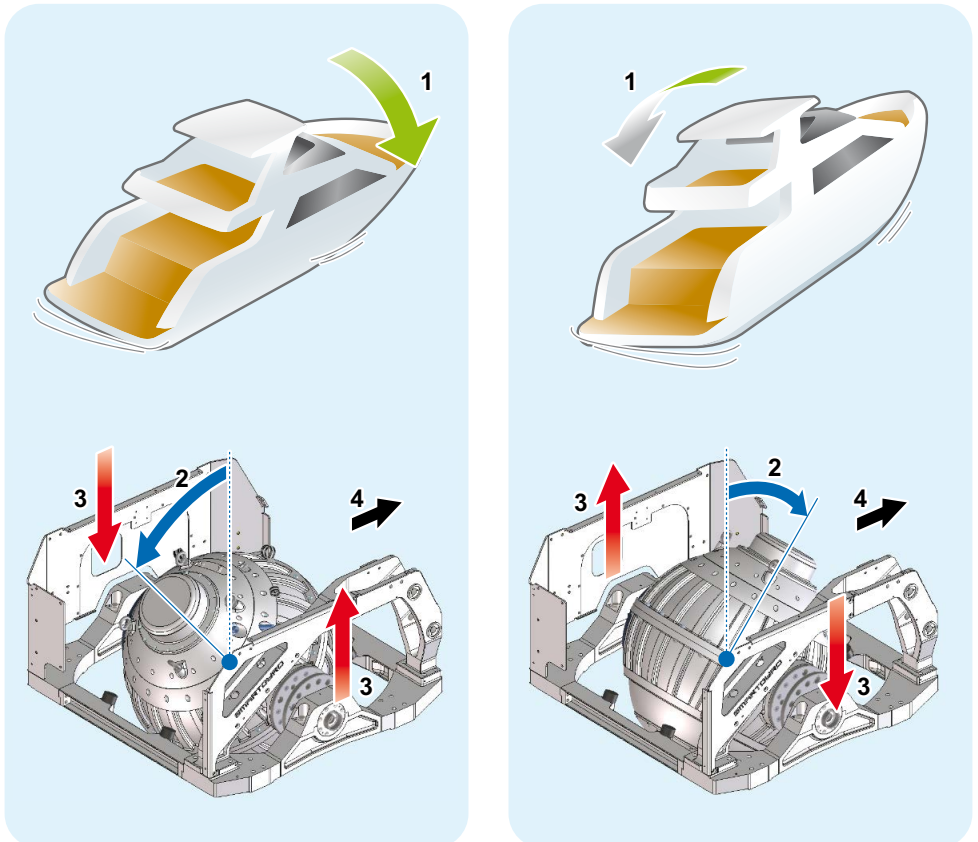

Figure 2

- 1. Boat tilt
- 2. Precession angle

- 3. Anti-roll torque
- 4. Bow

Component of SG80 Gyro Unit

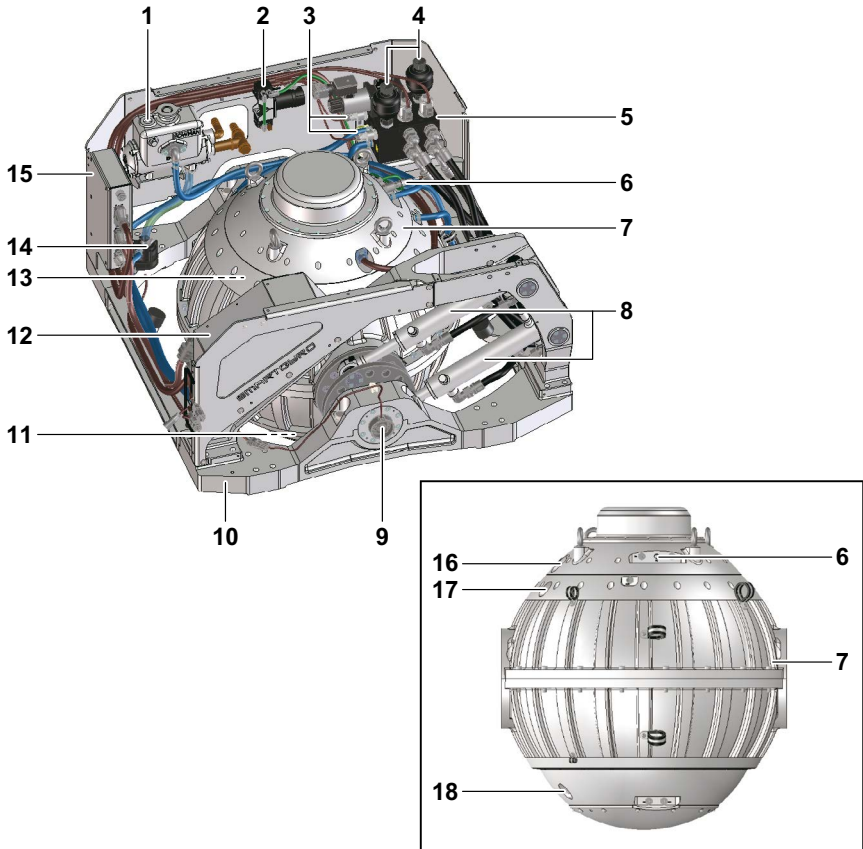

Figure 3

- | | |
|-----------------------------|-------------------------------------|
| 1. Heat exchanger | 10. Base frame |
| 2. Vacuum pump | 11. Lower bearing |
| 3. Pressure sensors | 12. Inverter box |
| 4. Accumulators | 13. Upper bearing |
| 5. Manifold | 14. Glycol pump |
| 6. Vacuum sensor | 15. Control box |
| 7. Gyro sphere and flywheel | 16. Motor sealed sleeve |
| 8. Hydraulic cylinders | 17. IR sensor (upper) sealed sleeve |
| 9. Precession angle sensor | 18. IR sensor (lower) sealed sleeve |

Description of SG80 Gyro Unit

The control unit monitors the system components and displays the information obtained on the control display.

The following components are monitored by the control unit.

Name of component	Description
Flywheel	The flywheel rotates inside the gyro sphere. It takes the flywheel about 45 minutes to accelerate from a standstill and reach top speed. It also takes about 120 minutes to decelerate from top speed to a complete halt.
Upper and lower bearings	Because the upper and lower bearings support the flywheel rotating at high speed, they are subjected to heavy loads and high temperatures. Therefore, the glycol pump circulates coolant to reduce the temperature of these bearings.
Vacuum pump	The vacuum pump creates a specific grade of vacuum state inside the gyro sphere to minimize air resistance generated when the flywheel rotates.
Hydraulic cylinders	Two hydraulic cylinders are used to brake and control the precession movement of the sphere. When the user wants to lock precession, the system applies a brake to the gyro sphere by blocking oil flow within the cylinders. In this condition no antiroll torque is generated by the gyro.

Description of control display

The control display is the interface between the user and the operation of the gyro unit. It is typically installed on the boat's helm station.

When the system is powered (DC 24 V), the display turns on and the splash screen is displayed (Smartgyro logo). After about 40 seconds since power on, the Home page (Figure 5) appears. The home page groups and displays the most important parameters of the gyro unit.



Figure 4

The main purpose of the display is to activate, control and monitor the gyroscope during its operation.

In the case of an anomaly, the display unit automatically warns the operator of the failure which has occurred, showing an anomaly message on a dedicated alarm log page.

The control display is a touchscreen device and can be operated by pressing the icons displayed on it.

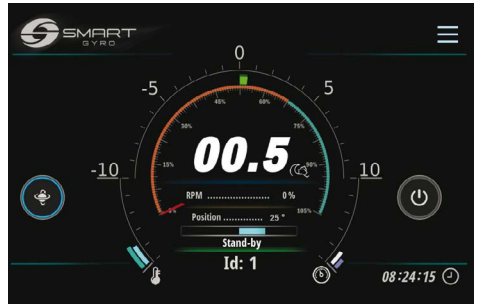

Figure 5

Home page

The following information fields are presented on the home page.

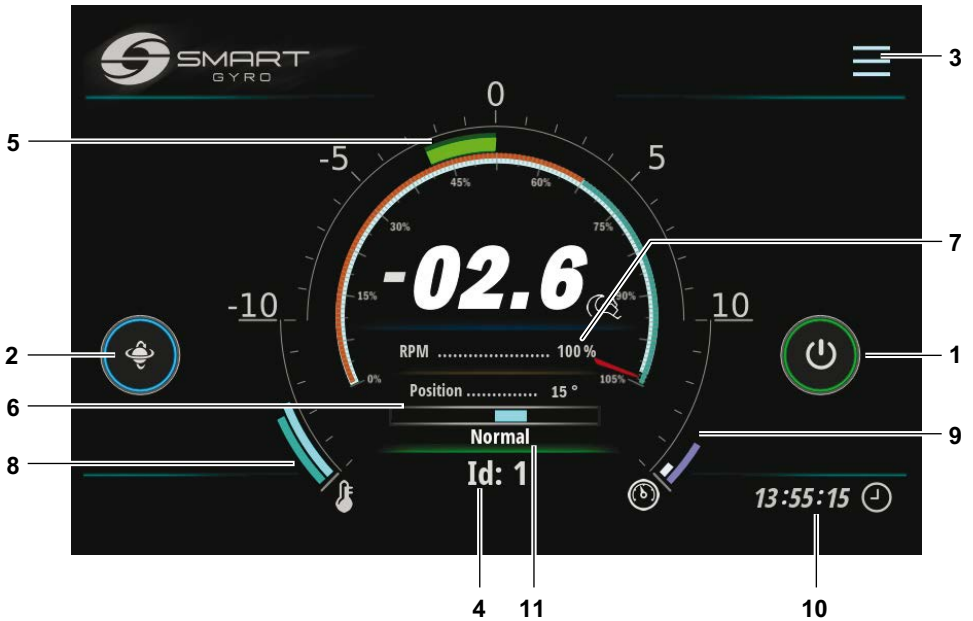

Figure 6

Display item	Description
1 Power (ON/OFF) icon	When the gyro system is powered, the outer circle of this icon is gray; when the icon is pressed, the circle turns green, indicating that the system is powered (basically that the motor drive is on) and running. If for any reason the stabilizer unit cannot be turned on, the circle remains gray.
2 Precession lock toggle icon	When the flywheel is accelerating and has not reached a minimum velocity (set at 55 % of top speed), the precession lock toggle icon has no effect on precession, which remains locked; this condition is signalled by the presence of yellow circle around the icon. Once the flywheel rotation speed has reached 55 % of top speed, the circle goes blue, and the functionality of the icon is enabled. A red circle indicates that precession is locked and no antiroll torque is generated. By pressing the icon, the circle is red and precession is locked. Pressing the icon again, the outer ring becomes blue, precession is unlocked and antiroll torque is generated (and so on, thereby toggling functionality).
3 Menu icon	By pressing this icon, it is possible to log into the various pages of the menu. See figure 17.

Display item	Description
4 Identification number	Displays the identification number of the gyro currently selected. The stabilizer identification number can be set in a password protected page of the Settings menu. In general, data presented on the various pages of the display refer to the gyro whose ID is selected (and displayed) on this page.
5 Roll angle	This information is derived from the IMU (Inertial Measurement Unit) inside the control box and is presented in both digital and analogue form; digital data is in a "two digits + sign" format. See "Indication of roll and pitch angles on page 16.
6 Precession angle (gyro sphere angular position)	Precession angle given in both digital and analogue. In digital form, it is presented as the actual angle (in degrees) of the gyro sphere with respect to the vertical. In analogue form, it is represented by a blue bar that originates from the center and goes to the left or the right depending on the angle of the sphere. See "Indication of precession angle" on page 17.
7 Speed indication	Flywheel rotation speed given in both digital and analogue. In digital form, it is shown as a percentage of top speed ("day" speed); when the system is accelerating, this indication goes from 0 % to 100 % (if the system is in "day" mode) or to 65 % (if in "night" mode). In analogue form, it is shown as a circular dial, whose red pointer indicates the actual speed, expressed as percentage of top speed.
8 Bearing temperatures	The temperatures of both upper and lower bearing packs are presented in the form of two curved segments whose length increases proportionally to the measured temperature.
9 Pressure of hydraulic circuits	The two pressure values are presented here in the form of two curved segments whose length is proportional to the pressure itself.
10 Local time (hours, minutes, seconds)	Hour information is stored in the battery-powered real-time clock inside the gyro's Control Unit. The local time can be set reaching the "Set time" option described on page 18.
11 Gyro working state	Indicates the current operating state ("mode") of the stabilizer. See table on page 25.

Indication of roll and pitch angles

A positive roll is observed when the starboard side of the vessel is angled upward (starboard up) (Figure 7).



Figure 7

A negative roll is observed when the port side of the vessel is angled upward (port up) (Figure 10).



Figure 10

A positive pitch is observed when the bow of the vessel is angled downward (bow down) (Figure 8).



Figure 8

A negative pitch is observed when the bow of the vessel is angled upward (bow up) (Figure 11).



Figure 11

If the roll is positive, the semi-circular bar on the Home page moves to the right (Figure 9).

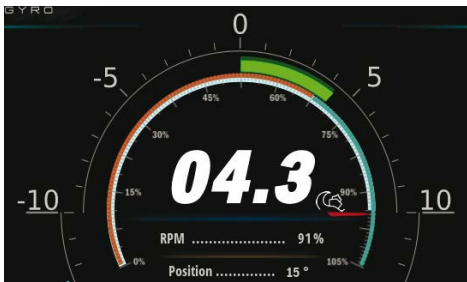

Figure 9

If the roll is negative, the semi-circular bar on the Home page moves to the left (Figure 12).

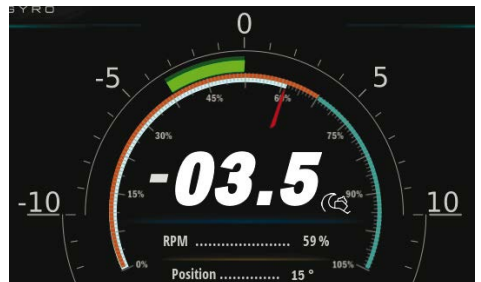

Figure 12

Indication of precession angle

Precession angle is positive when the gyro sphere is tilted toward the bow (in "Typical installation" mode – (see the Installation manual for more information on Installation modes - "Typical" and "Reverse") (Figure 13).

Precession angle is negative when the gyro sphere is tilted toward the aft (in "Typical installation" mode (Figure 15).

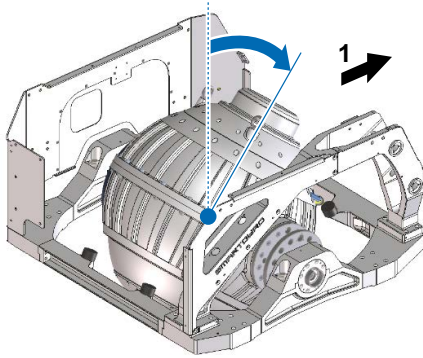

Figure 13

1. Bow

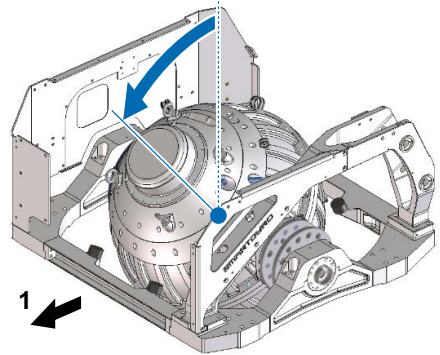

Figure 15

1. Aft

When precession is positive, the blue bar on the home page goes to the right (Figure 14).

When precession is negative, the blue bar on the home page goes to the left (Figure 16).



Figure 14

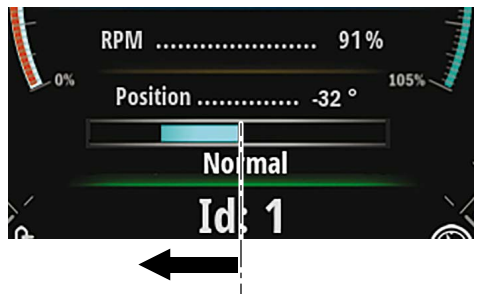

Figure 16

Setting the control display

Pressing the Menu icon page (Figure 6, (3)) some function icons appear at the top right corner of the screen (Figure 17).

Pressing the Setting icon (Figure 17, (1)) will take you to the Setting menu page (Figure 18).

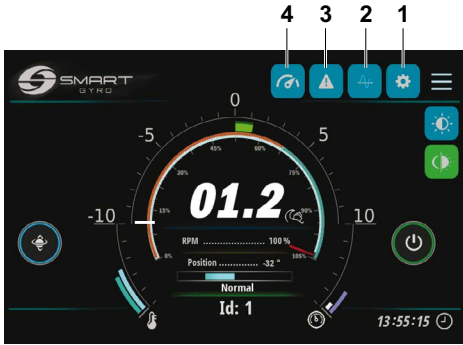

Figure 17

Four options are available:

- "Set time"
- "Info"
- "Language"
- "Unit of measure"

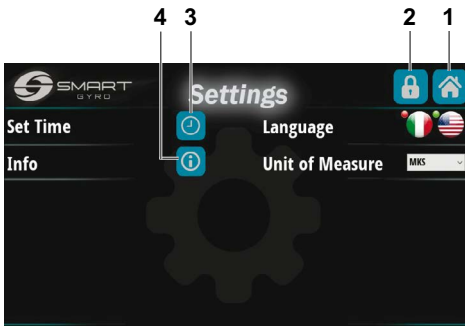

Figure 18

Pressing the Home icon on the top right corner (Figure 18, (1)) will return you to the Home page.

Pressing the icon with the padlock symbol (Figure 18, (2)), will take you to a password protected page (only accessible to service personnel) for inspecting/modifying some internal parameters that are typically accessed during the first time installation of the gyro.

"Set time" option

Pressing the Set Time icon with the clock symbol (Figure 18, (3)), will take you to the Time and Date setting page (Figure 19).

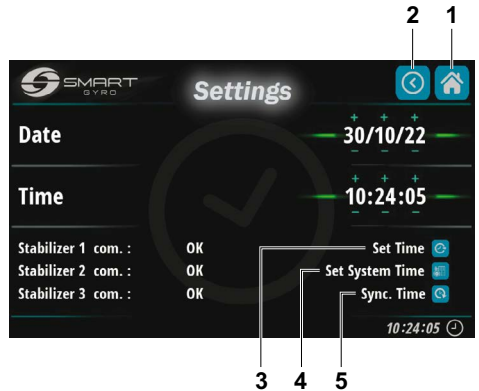

Figure 19

The actual time and date (as retrieved from the internal real-time clock of the gyro Control Unit) are displayed in the six data fields on this page.

The numerical fields of the Date (day/month/year) and Time (hours/minutes/seconds) can be set simply pressing the corresponding symbols “+” and “-” placed above and below the numbers.

Once the date and time are set, data are saved into the non-volatile memory of the gyro’s Control Box by pressing the uppermost icon at the bottom right angle (Figure 19, (3)).

Pressing the central icon (Figure 19, (4)) saves the time and data into the non-volatile memory of the display.

Finally, pressing the bottom-most icon (Figure 19, (5)) discards the data and shows on the screen the current date and time read from the internal Real Time Clock of the gyro’s Control Box.

Note

- More gyros (and displays) can be connected to the same CAN bus.
In this case, setting the date and time on one display affects all the connected gyros, if these are properly connected and powered; i.e. the new date and time are sent to all the connected gyros, so that one programming only is needed to set all.
It may happen, however, that for any reason some gyros are not operative (for example, not powered).
The current status of the stabilizers is shown on the bottom left of the page.

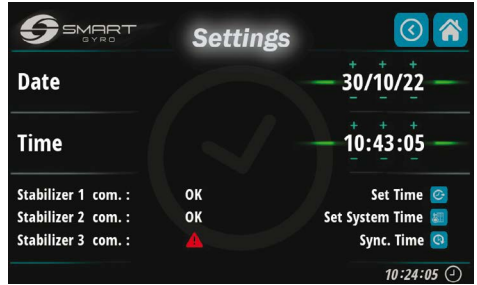

Figure 20

In this example only gyros n°1 and 2 are responding (gyro 3 has a red anomaly mark). Therefore the new date and time will only be set on gyros 1 and 2.

Pressing the Home icon on the top right corner (Figure 19, (1)) will return you to the Home page.

Pressing the Back icon on the top right corner (Figure 19, (2)) will return you to the Settings page (Figure 18).

“Language” option

Two languages are currently available:

- Italian
- English

Selection is made by pressing the corresponding flag icon.

“Unit of measure” option

With the “Units of measure” option, it is possible to select between International System of Units (MKS) and imperial units (UCS).



Figure 21

“Info” option

Pressing the Info icon (Figure 18, (4)), it is possible to visualize the firmware versions of both the display and the control board (installed on the gyro unit) (Figure 22).

The upper five rows all refer to the software packages residing on the display, the lowest to the Control Unit of the gyro unit.

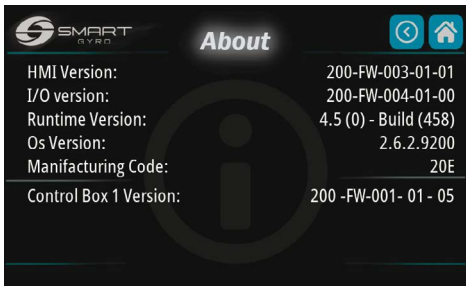

Figure 22

Adjusting the brightness of the control display

Pressing the brightness icon on the setting page (Figure 23, (1))

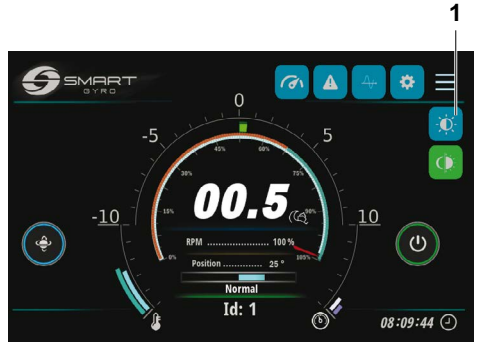

Figure 23

brings up an adjusting knob on the left part of the screen (Figure 24).

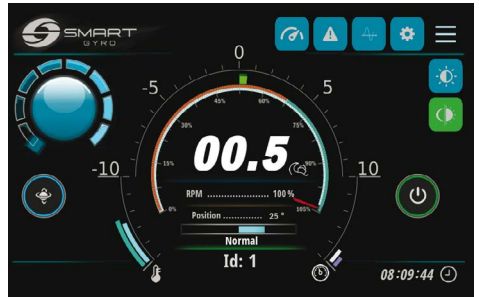

Figure 24

The brightness level can be adjusted by turning the knob.

The knob disappears if the central part of the knob itself is pressed.

Roll Angle Monitor Page

- By pressing the Roll icon (Figure 25, (1))

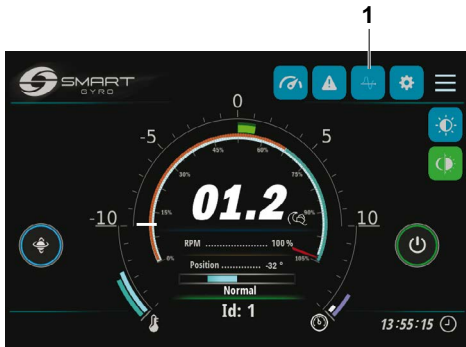

Figure 25

the Roll Angle page is visualized on the display (Figure 26).

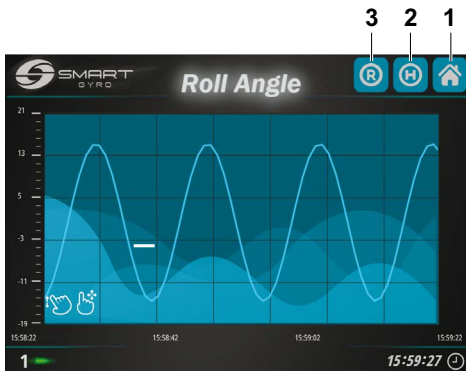

Figure 26

It shows, in a graphical way, the amplitude of the roll angle versus time. Both scales of X and Y axes can be varied with gestures.

Pressing the “R” icon on the top right corner (Figure 26, (3)), the visualization of the graph is started; the graph scrolls to the left.

When the visualization is started, the graph is autoscaled, i.e. the upper and lower limits of the Y axis are automatically adjusted to fit the actual roll values.

Once the Y scale is set with the gestures, it remains fixed, and does not change automatically anymore.

Pressing the “H” icon (Figure 26, (2)), the display visualizes the data stored in the non volatile memory of the Display, as a background process.

Using gestures (left/right scroll) it is possible to visualize different time slots.

Pressing in the middle of the graph causes a red vertical bar to appear; it can be used as a bookmark to indicate a certain time of interest.

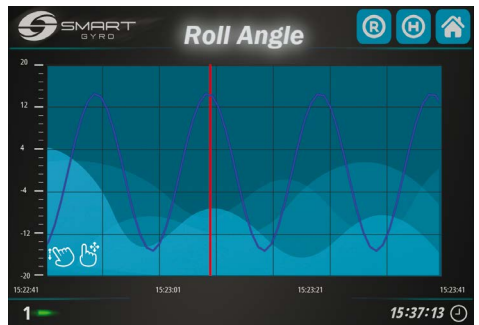

Figure 27

Pressing the Home icon on the top right corner (Figure 26, (1)) will return you to the Home page.

Alarm Log Page

When the gyro system detects an anomaly, a warning message is presented at the bottom of the Home or Performance page.

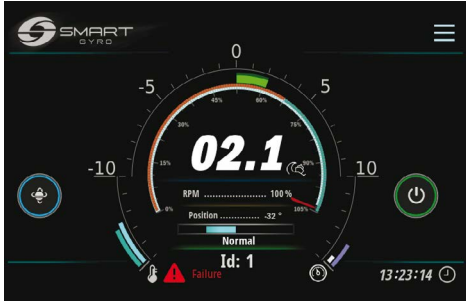

Figure 28

Pressing the alarm icon (Figure 17, (3)) will take you to the alarm log page.



Figure 29

Anomaly messages are displayed in three different colours, depending upon their state:

- Red: Anomaly still present, and not acknowledged by the operator.
- Green: Anomaly still present, but acknowledged by the operator.
- Grey: Anomaly no longer present (regardless of whether it was acknowledged).

If the check list icon is pressed (Figure 29, (2)), the alarm messages will change to green (alarms are “acknowledged”).



Figure 30

Alarm messages remain displayed on the alarm page even if the failure is not present anymore. In this case, however, the relevant message is coloured in grey.



Figure 31

In the example above the overtemperature failure in upper and lower bearings has been fixed (grey colour) but the low pressure anomaly remains (acknowledged – green-).

The content of the alarm log page is not fixed, but varies depending on the number and type of detected anomalies.

As the number of anomalies gradually increases, they are added to the list. Accordingly, the bottom line always represents the most recent one.

The column “Time” indicates the time of occurrence of the anomaly, while the column “code” is a numerical code for identifying the anomaly.

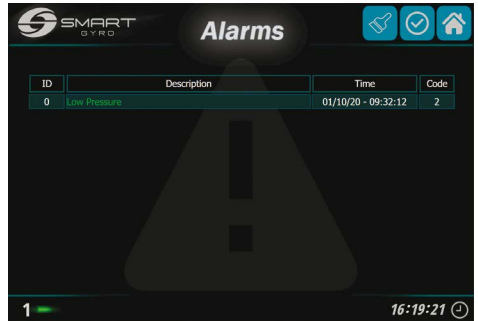

Figure 32

Alarms not present anymore in the system can be removed from the list (Figure 32), pressing the paint brush symbol icon (Figure 29, (3)). As in the performance monitor page (see next paragraph), the bottom right corner shows the ID number of the gyro the anomalies refer to.

Pressing the Home icon on the top right corner (Figure 29, (1)) will return you to the Home page.

Performance Monitor Page

Pressing the performance monitor page icon (Figure 17, (4)) will take you to the performance monitor page (Figure 33).

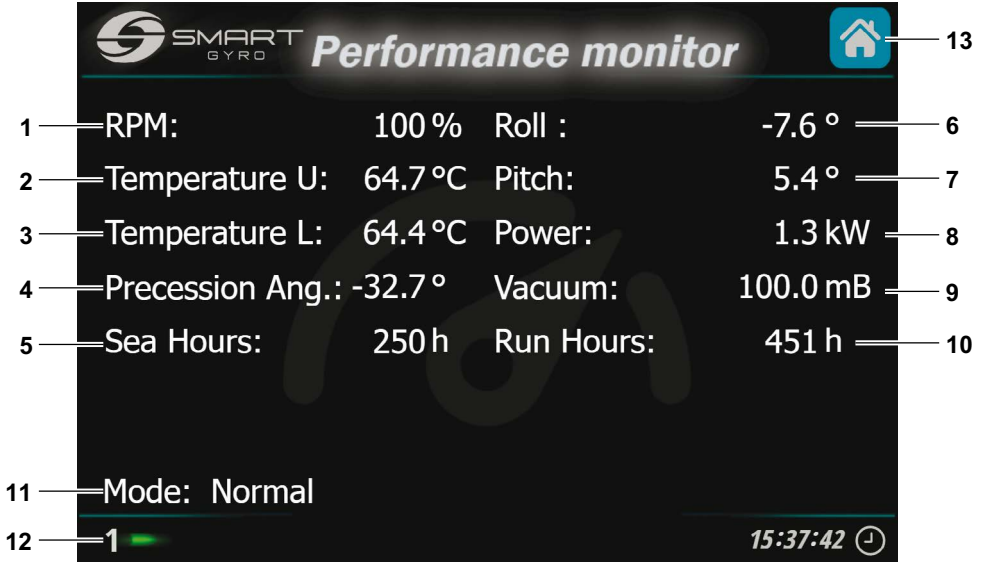

Figure33

The following items are displayed on this page.

Display item	Description
1 "RPM"	Flywheel rotation speed, expressed as percentage of top speed.
2 "Temp. U"	Temperature of the upper bearing pack (°C or °F).
3 "Temp. L"	Temperature of the lower bearing pack (°C or °F).
4 "Precession Angle"	Actual precession angle, expressed in degrees. See "Indication of precession angle" on page 17.
5 "Sea H."	Number of hours during which precession has remained free (unlocked).
6 "Roll"	Actual roll angle, expressed in degrees. See "Indication of roll and pitch angles" on page 16.
7 "Pitch"	Actual pitch angle, expressed in degrees. See "Indication of roll and pitch angle" on page 16.
8 "Power"	Power absorbed by the system (kW).
9 "Vacuum"	Vacuum level inside the gyro sphere (mbar or psi).

Display item	Description
10 "Run H."	Number of hours during which the gyro system has been powered
11 "Mode"	This field indicates the actual state of the gyro stabilizer; it can be any of these: <ul style="list-style-type: none"> "STANDBY" The system is ready to operate but the flywheel is still and not powered. "WAIT START SPINNING" This mode is entered when the ON/OFF button is pressed for activating the flywheel rotation and remains until the motor drive has acknowledged the command. "SPEEDING UP" The flywheel is accelerating but has not reached the minimum operating speed. "NORMAL" The flywheel has reached the minimum operating speed (precession can be unlocked). "LOW LEVEL FAILURE" The system has detected a low-level failure; this state remains as long as the anomaly is present. When the failure condition is restored, the system automatically goes into "STANDBY" mode. See "TROUBLESHOOTING" on page 38. "HIGH LEVEL FAILURE" The system has detected a high-level failure and the system automatically shuts off the gyro system. See "TROUBLESHOOTING" on page 38. "STOP SPINNING" A state in which the power supply to the gyro motor is cut and the flywheel decelerates in a controlled way (i.e. following a pre-set deceleration ramp). This state continues until the flywheel comes to a complete stop. "MAIN OUTAGE" The system enters this state when AC power is disconnected. When power is recovered, the system automatically returns to the state it was in before the anomaly. "INITIALIZING SYSTEM" This mode remains for a few seconds after powering on the control box and is only visible if the display has remained powered. "WAIT INVERTER BOOT", "WAIT INVERTER DATA" These modes are entered after system initialization and remain until the motor drive has completed its initialization phase. "SERVICE" This mode is entered when the Service Sw app is connected to the gyro (option only available for installers and service technicians).
12 Gyro ID number	The data displayed in this page refer to the stabilizer whose ID number is displayed at the bottom left corner of the page (1 In this example).
13 Home page icon	Pressing the icon will take you to the Home page.

Gyro stabilizer operation

Introduction

This section of the Operation Manual concerns how to operate the Smartgyro SG80.

Safety precautions

Before performing any operations within this section, review the SAFETY section on page 3.

 **WARNING**



Keep away while the gyro stabilizer is operating.

NOTICE

If there is an anomaly while the gyro stabilizer is operating, identify the cause and fix the problem. Depending on the abnormal condition, stop the operation of the gyro stabilizer.

Before operating the gyro stabilizer, open the seawater intake/outlet of the seawater pump. Also, close the seawater intake/outlet after the operation is stopped.

Gyro Stabilizer Startup and Stabilization

1. Ensure that both the AC power and DC power lines are connected to the gyro system.
2. Switch on the protection breakers on the DC and AC power lines. It may happen that if the DC power is turned on before AC power, the system will detect an AC power absence fault. However, this disappears as soon as AC power supply is supplied.

Note:

- When the control display is powered on, a splash screen will appear (Figure 1); after about 40 seconds, the Home page will be displayed on the screen (Figure 2).
- If an anomaly is detected, it is signaled by the presence of a red icon on the bottom left corner (see Figure 3)



Figure 1

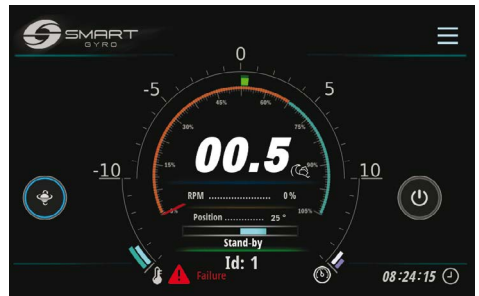

Figure 3



Figure 2

- For information about displayed anomaly messages and how to handle them, see "TROUBLESHOOTING" on page 38.

GYRO STABILIZER OPERATION

3. Press the Power (ON/OFF) icon (Figure 4, (1)) to power on the gyro unit.
4. Make sure the seawater and glycol pumps are operating.

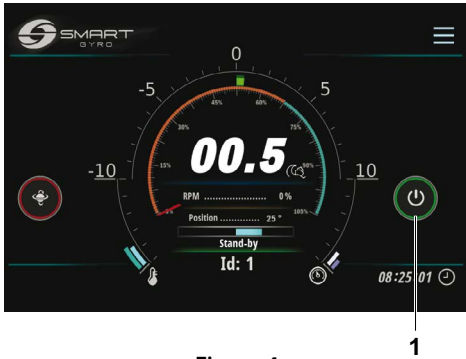

Figure 4

Note:

- When the power of the gyro unit is turned on, the circle around the ON/OFF icon turns green.
- When the gyro unit is powered, the flywheel will start accelerating, the speed indication marker will move along the dial on the Home page, and the actual speed value will be expressed as a percentage of full speed and will increase over time. For details on the display, see “Home Page” on page 14.
- If for any reason it is not possible to turn on the stabilizer unit (for example for a ‘no communication’ anomaly on the CAN line between the motor drive and the control board), the circle around the ON/OFF remains grey. Check the details of the anomaly on the alarm log page, see “Alarm Log Page” on page 22.
- For information about displayed anomaly messages and how to handle them, see “TROUBLESHOOTING” on page 38.

Note:

- If the seawater pump is connected to a circuit other than the gyro system, turn on the power to operate the seawater pump.
 - If you connect the seawater pump directly to the gyro system, the system will also activate the seawater pump when the flywheel reaches about 300 RPM (it takes about 3 minutes to reach this speed).
5. Press the night/day selection icon (Figure 5, (1)) to select the desired operating speed.

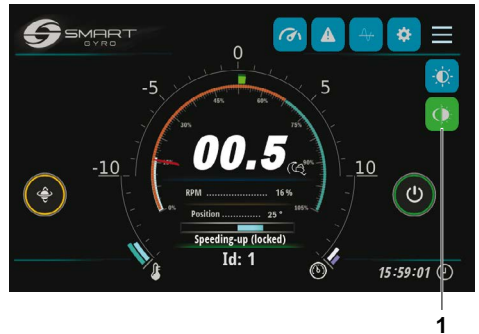

Figure 5

If night mode is chosen, the icon is blue; when in day mode, the icon is green.

Note:

The night mode flywheel speed is 65 % of the day mode flywheel speed.

6. During flywheel acceleration and as long as the speed remains below 55% of the top speed, precession is not allowed and the circle around the precession icon (Figure 6, (1)) is yellow.

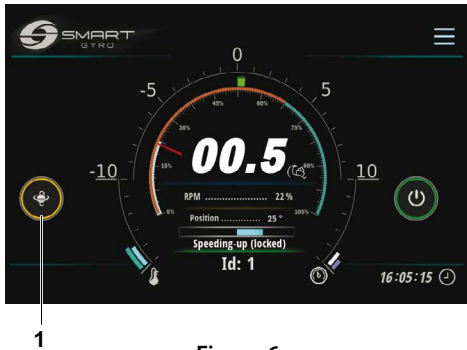

Figure 6

7. After the flywheel speed exceeds 55 % of the top speed, precession is allowed and the circle around the icon goes blue, indicating that precession is unlocked and the sphere is able to oscillate (Figure 7, (1)).

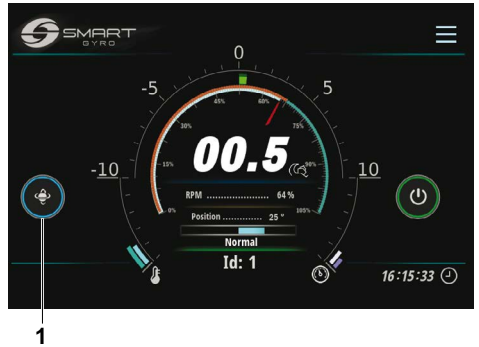

Figure 7

8. To stop the precession, press the precession toggle icon. The circle around the icon goes red, indicating that the precession is locked and the sphere cannot rotate (Figure 8, (1)).

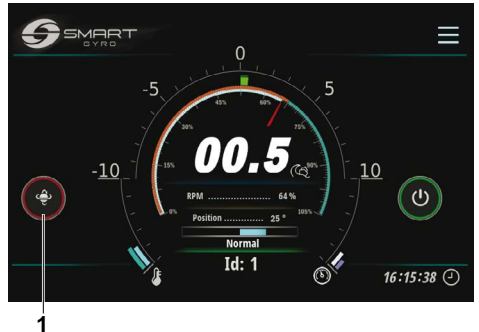

Figure 8

9. Press the icon again to allow precession (toggle functionality).

Note:

- It takes about 20 minutes for the flywheel to reach 55 % of the top speed
- After the flywheel speed reaches 55 % of the top speed, it will reach the set speed in about 25 minutes in day mode and about 5 minutes in night mode.

Note:

- Precession is locked and stabilization is turned off when the boat is turning at high speed with a small turning radius. The IMU (Inertial Measurement Unit) of the gyro system automatically senses this condition and activates precession lock; precession movements and consequently stabilization is automatically restored whenever this high acceleration state is no longer present.
- During precession lock due to high acceleration conditions, the circle around the precession icon turns red, as when precession is intentionally stopped.

Temperature derating

If, during normal operation, an over temperature condition is found in the gyro (in the internal bearings or in the Inverter Box), the system automatically reduces the power supplied to the motor, in order to keep the temperature within safe limits; flywheel speed is reduced as well.

This condition is indicated by an orange thermometer icon displayed on the bottom left of the Home page (Figure 9).

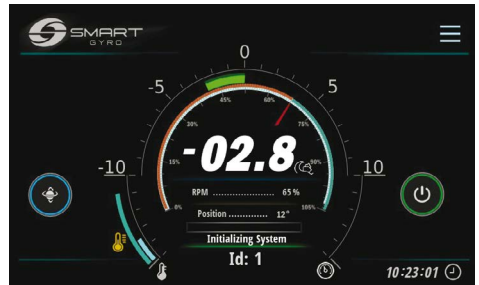

Figure 9

This condition may happen, for example, if sea-water hoses connected to the heat exchanger are clogged.

Normal operating conditions are automatically restored once the over temperature condition has been removed.

Gyro Stabilizer Shutdown

1. Go to the home page.
2. Press the power (ON/OFF) icon (Figure 10, (1)).



Figure 10

Note:

- The circle around the power (ON/OFF) icon goes grey and the circle around the precession lock toggle icon goes red: precession is locked and the flywheel begins to decelerate.
- When you press the icon and turn off the gyro, power is removed from the motor and the flywheel begins to decelerate; the flywheel speed is still shown on the display up to about 500 rpm but not below that. Wait at least 15 minutes after the flywheel speed indication disappears before approaching the gyro.
- If the flywheel was spinning at full speed, it will take about 2 hours to come to a complete stop.

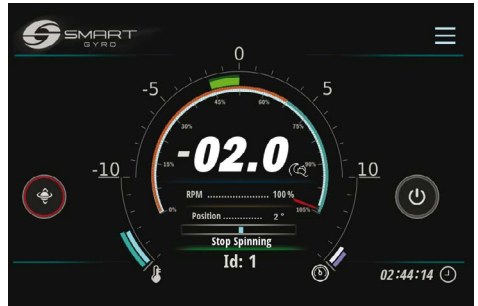

Figure 11

3. Make sure the flywheel is completely stopped, turn off the seawater pump (if connected to a circuit other than the gyro system), and turn off the DC and AC power protection breakers.

Note:

- If the seawater pump is driven by the gyroscope, it remains powered as long as the flywheel speed is above 300RPM. When the speed drops below this value, the pump is de-energized. However, even below this speed, if the bearings temperature is above 45°C, the pump will remain in operation.
- The glycol pump, on the other hand, remains energized even when the flywheel is stopped and as long as the temperature of bearings is above 45°C.

Emergency shutdown

Emergency shutdown is a method to stop the rotation of the flywheel, by forcing the motor drive to cut power to the motor by means of a hardware circuitry and not via a software command (as during normal shutdown).

This shutdown mode can be invoked by the operator, for example when there is an anomaly in the communication line with the motor drive (in these conditions the motor drive cannot receive any stop command).

Follow the normal shutdown procedure except in an emergency.

1. Display the home page.
2. Keep pressed the power (ON/OFF) icon (Figure 12, (1)) for about 3 seconds.



Figure 12

Note:

- When an emergency shutdown is performed, the “Emergency Stop” pop-up (Figure 12,) flashes on the display.
- When performing an emergency shutdown, the speed indication is not displayed because the power to the motor is cut off.
- If the flywheel was running at top speed, it will take about 2 hours to stop completely.
- To clear the EMERGENCY STOP label, returning to the normal Home page screen, press the “EMERGENCY STOP” banner in the middle of the screen.
- To restart the system, press the power (ON/OFF) icon.

Periodic maintenance

Introduction

In order to assure the best performance and the correct functionality of the gyro stabilizer it is very important to perform the required maintenance activities.

The gyro stabilizer is a complex machine, composed of different subassemblies (mechanical/ electrical/ hydraulic) that operate in a potentially corrosive environment (salty, wet and hot spaces, like engine rooms).

For this reason, in order to avoid the effects of corrosion as much as possible, it is necessary to remove salt deposits on gyro unit surfaces as frequently as possible, possibly wiping them down with mild soap and water and rinsing.

This section of the instruction manual describes maintenance details and maintenance intervals.

Safety precautions

Before performing any maintenance procedures within this section, read the following safety information and review the SAFETY section on page 3.

WARNING

Crush Hazard



If the gyro unit needs to be transported for repair, have a helper assist you to remove it from the boat with a hoist.

The lifting eyes are engineered to lift the weight of the gyro unit only. Always use the lifting eyes when lifting the gyro unit.

Always use lifting equipment with sufficient capacity to lift the gyro unit.



Tool Hazard

Always remove any tools or shop rags used during maintenance from the area before operation.

NOTICE

Any part which is found defective as a result of inspection, or any part whose measured value does not satisfy the standard or limit, must be replaced.

Modifications may impair the gyro stabilizer safety and performance characteristics and shorten the life of the gyro stabilizer. Any alterations to this gyro stabilizer may void its warranty. Be sure to use genuine Smartgyro replacement parts.

Precautions

The Importance of Periodic Maintenance

Periodic maintenance prevents unexpected downtime, reduces the number of accidents due to poor machine performance and helps extend the life of the gyro stabilizer.

Keep a Log of Operation Hours and Daily Checks

Keep a log of the number of operation hours each day and a log of the daily checks performed. Also note the date, type of repair and parts used for any service needed between the periodic maintenance intervals. Periodic maintenance intervals are every 300, 500, 1000, and 2000 hours. Failure to perform periodic maintenance will shorten the life of the gyro stabilizer.

NOTICE

Failure to perform periodic maintenance will shorten the life of the gyro stabilizer and may void the warranty.

Smartgyro Replacement Parts

Smartgyro recommends that you use genuine Smartgyro parts when replacement parts are needed. Genuine replacement parts help ensure a long life for the gyro stabilizer.

Tools Required

Before you start any periodic maintenance procedure, make sure you have the tools you need to perform all of the required tasks.

Consult Your Authorized Smartgyro Dealer or Distributor for Help

Our professional service technicians have the expertise and skills to help you with any maintenance or service-related procedures you need help with.

Periodic maintenance schedule

Periodic maintenance is important to keep the gyro stabilizer in good operating condition. The following is a summary of maintenance items by periodic maintenance intervals. Periodic maintenance intervals vary by usage conditions and environment and are difficult to establish clearly. The following should be treated only as a general guideline.

NOTICE

Establish a periodic maintenance plan and make sure to perform the required periodic maintenance at the intervals indicated. Failure to follow these guidelines will impair the safety and performance characteristics of the gyro stabilizer, shorten the life of the gyro stabilizer and may affect the warranty coverage on your gyro stabilizer.

If repairs and/or part replacement are/is required based on the inspection results, please contact an authorized Smartgyro dealer or distributor.

○ = Service operation

System	Item	Periodic Maintenance Interval			
		Every 300 hours or 6 months *1	Every 6 months or 500 hours *1	Every 12 months or 1000 hours *1	Every 24 months or 2000 hours *1
Mechanical assembly	Check the metal outer surface for corrosion. If there is corrosion, remove the corrosion and touch up with paint.			○	
	Check the tightening of the mounting bolts between the gyro base frame and the boat stringers.		○		
	Check the tightening of the bolts between the upper bearing support and the gyro base frame.		○		
Electrical subsystem	Check all connectors for corrosion and proper connection to mating counterparts.			○ Every 12 months	
	Check all wire harnesses for rubbing and crushing.			○ Every 12 months	
	Check the tightness of the IR sensor and motor sealed sleeves on the gyro sphere.			○ Every 12 months	
	Check that the earthing/grounding wire is securely attached to the ground stud on the base frame.			○ Every 12 months	

*1. Whichever comes first

PERIODIC MAINTENANCE

System	Item	Periodic Maintenance Interval			
		Every 300 hours or 6 months *1	Every 6 months or 500 hours *1	Every 12 months or 1000 hours *1	Every 24 months or 2000 hours *1
Electrical subsystem	Check all earthing/grounding wires for corrosion. If there is corrosion, remove the corrosion and treat with a corrosion inhibitor.			○ Every 12 months	
	Check that the power lines between the boat and the gyro unit are securely connected and that the external jacket of the power lines are not damaged.			○ Every 12 months	
Brake system	Check that there are no oil leaks from the cylinders, the hoses and the manifold.		○		
	Check that the gyro sphere is locked when precession is not permitted. If it is not locked, perform air purging of the hydraulic circuit and, in case, flush and refill the hydraulic circuit (AW 46 oil).		○		
	Flush and refill the hydraulic circuit (AW 46).			○	
	Check the cylinder bushing and spacers for wear and damage.			○	
	Replace the cylinder bushing and spacers.				○ Every 2000 hours
	Grease up the cylinder rod eye. (Using Molykote Longterm grease or an equivalent product)			○ Every 1000 hours	
	Check the hydraulic cylinders and hoses for wear and damage. When the parts are replaced, the air purge of the hydraulic circuit is performed and the hydraulic oil (AW 46) is replenished.			○	
	Check the hydraulic accumulators.			○	
	Replace the hydraulic accumulators.				○
Cooling system	Check for anode erosion. Replace if 50 % eroded.	○			

*1. Whichever comes first

System	Item	Periodic Maintenance Interval			
		Every 300 hours or 6 months *1	Every 6 months or 500 hours *1	Every 12 months or 1000 hours *1	Every 24 months or 2000 hours *1
Cooling system	Check that there are no leaks in the cooling circuit (fittings, hoses, heat exchanger).		○		
	Check the coolant level. Top up the coolant with a mixing ratio of 50 (ethylene glycol) to 50 (soft water) if necessary.		○		
	Check the heat exchanger for damage.			○	
	Descale the heat exchanger.			○	
	Disassemble and descale the heat exchanger. If descaling is not possible, replace it.				○
	Coolant flush and refill.				○
	Check the cooling hoses for wear and damage. When the parts are replaced, the air purge of the cooling circuit is performed and the coolant is replenished with a mixing ratio of 50 (ethylene glycol) to 50 (soft water).			○ Every 12 months	
	Check that the seawater inlet/outlet hoses of the heat exchanger are securely connected and that the relevant hose clamps are not corroded and securely fastened.		○ Every 6 months		
	Check that the seawater hoses reaching the heat exchanger are not clogged. Clean or replace if clogged.		○ Every 6 months		
Vacuum system	Check that the vacuum circuit hoses are securely connected and that the hoses are not rubbed or damaged. Replace if rubbed or damaged.			○ Every 12 months	
	Check that the vacuum pump is securely fixed and that the mounting screws are not corroded. If there is corrosion, remove the corrosion and treat with a corrosion inhibitor.			○ Every 12 months	

*1. Whichever comes first

Troubleshooting

Safety precautions

Before performing any troubleshooting procedures within this section, review the SAFETY section on page 3.

Troubleshooting information

Inspection for failure measures, repair, and replacement require specialized expertise. If you do not have the specialized expertise, contact your authorized Smartgyro dealer or distributor.

Supply the authorized Smartgyro dealer or distributor with the following information:

- Model name and serial number of your gyro stabilizer
- Total number of operation hours
- Displayed alarm log (if alarm log is detected)
- Anomaly status (gyro stabilizer status)

Gyro system anomaly

There are two types of gyro system anomalies: low-level anomalies and high-level anomalies.

All of them are presented and treated in the same way in the Alarm Log page.

In the occurrence of a low-level anomaly, the gyro system will continue to operate, but in the occurrence of a high-level anomaly, it will lock the precession and stop the motor. In addition, alert icons (Figure 1, (1)) flash on the home page to notify you of the occurrence of the high-level anomaly.

The alert icons disappear automatically when the anomaly is cleared.

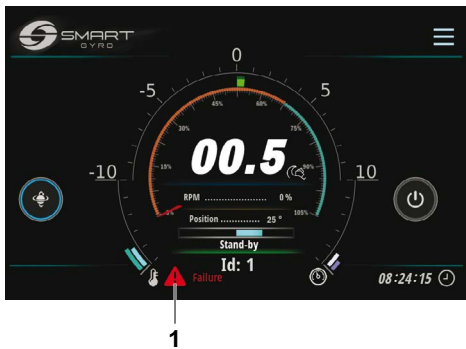

Figure 1

Troubleshooting chart

The following table summarizes the actions that can be taken once an anomaly occurs in the gyro system.

- *1. When the DC power is restored, the system automatically returns to the standby state. Therefore, to resume normal operation, press the power (ON/OFF) icon.
- *2. Precession is permitted as long as the flywheel speed remains above 55 % of full speed.

√ = The alert icons flash on the home page.

– = The alert icons do not appear.

Anomaly message	Symptom of gyro stabilizer	Cause	Action	Alert icon flashes
No message	Display blank *1	DC power is not being supplied to the control display.	<ul style="list-style-type: none"> • Check that the DC breaker has not tripped. • Check that the wiring between the gyro unit and the control display is properly connected. • Check that the pigtailed associated with the inverter box are securely connected. • Contact Smartgyro dealer or distributor if the fault remains. 	–
“Mains Outage”	Motor drive disabled (flywheel deceleration) *2	AC power is not being supplied to the gyro unit.	<ul style="list-style-type: none"> • Check that the AC breaker has not tripped. • Contact Smartgyro dealer or distributor if the fault remains. 	√
“IMU Absence” “IMU Corrupted”	<ul style="list-style-type: none"> • Motor drive disabled (flywheel deceleration) • Precession is not allowed 	IMU (Inertial Measurement Unit) is not communicating with the mainboard.	<ul style="list-style-type: none"> • Contact Smartgyro dealer or distributor if the fault remains. 	√
“Prec. Sensor Fail”	<ul style="list-style-type: none"> • Motor drive disabled (flywheel deceleration) • Precession is not allowed 	The connection with the precession sensor is disconnected, or the value received from the precession sensor is invalid.	<ul style="list-style-type: none"> • Check that the connector is securely connected to the precession sensor. • Check that the screws fixing the precession sensor to the mounting plate are correctly tightened. • Contact Smartgyro dealer or distributor if the fault remains. 	√

Anomaly message	Symptom of gyro stabilizer	Cause	Action	Alert icon flashes
"Low Pressure"	<ul style="list-style-type: none"> • Motor drive disabled (flywheel deceleration) • Precession is not allowed 	The pressure in either of the two hydraulic circuits has dropped.	<ul style="list-style-type: none"> • Check that the connector is securely connected to the pressure sensor on the manifold. • Contact Smartgyro dealer or distributor if the fault remains. 	√
"Press. Sens. 1 Fail" "Press. Sens. 2 Fail" (both detected)	<ul style="list-style-type: none"> • Motor drive disabled (flywheel deceleration) • Precession is not allowed 	Both connections with the pressure sensors are disconnected or their value is invalid.	<ul style="list-style-type: none"> • Check that the connectors are securely connected to the pressure sensors on the manifold. • Contact Smartgyro dealer or distributor if the fault remains. 	√
"Press. Sens. 1 Fail" "Press. Sens. 2 Fail" (either detected)	Normal operation	One of the two connections with the pressure sensors is disconnected or its value is invalid.	<ul style="list-style-type: none"> • Check that the connector is securely connected to the pressure sensor on the manifold. • Contact Smartgyro dealer or distributor if the fault remains. 	–
"Upp. Bearings Ovt" "Lwr Bearings Ovt."	<ul style="list-style-type: none"> • Motor drive disabled (flywheel deceleration) • Precession is not allowed 	Overtemperature detected on either of the two bearing packs.	<ul style="list-style-type: none"> • Check the coolant level of the heat exchanger. Replenish as needed. • Check that the glycol pump is working. • Check the input glycol pump input voltage. • Check that the three connectors on the control box are securely connected. • Check if the seawater pump is working. If it is not working, check that the protective breaker is not tripped, that the wiring is securely connected between the seawater pump and inverter box, and that there is AC voltage presence at the seawater pump terminals. • Check the seawater pump strainer, and clean if clogged. • Contact Smartgyro dealer or distributor if the fault remains. 	√

TROUBLESHOOTING

Anomaly message	Symptom of gyro stabilizer	Cause	Action	Alert icon flashes
"Motor Overtemperature"	<ul style="list-style-type: none"> Motor drive disabled (flywheel deceleration) Precession is not allowed 	Overtemperature detected on the motor.	<ul style="list-style-type: none"> Check the coolant level of the heat exchanger. Replenish as needed. Check that the glycol pump is working. Check the input glycol pump input voltage. Check that the three connectors on the control box are securely connected. Check if the seawater pump is working. If it is not working, check that the protective breaker is not tripped, that the wiring is securely connected between the seawater pump and inverter box, and that there is an AC voltage presence at the seawater pump terminals. Check the seawater pump strainer, and clean if clogged. Contact Smartgyro dealer or distributor if the fault remains. 	√
"U. Temp. Sens. Fail" "L. Temp. Sens. Fail" (both detected)	<ul style="list-style-type: none"> Motor drive disabled (flywheel deceleration) Precession is not allowed 	Both connections with the temperature sensors are disconnected or their value is invalid.	<ul style="list-style-type: none"> Check that the IR sensors located on the gyro sphere are securely mated to the corresponding connectors of the gyro unit wiring. Contact Smartgyro dealer or distributor if the fault remains. 	√
"U. Temp. Sens. Fail" "L. Temp. Sens. Fail" (either detected)	Normal operation	One of the two connections with the temperature sensors is disconnected or its value is invalid.	<ul style="list-style-type: none"> Check that the IR sensors located on the gyro sphere are securely mated to the corresponding connectors of the gyro unit wiring. Contact Smartgyro dealer or distributor if the fault remains. 	-
"Motor Driver Fail"	<ul style="list-style-type: none"> Motor drive disabled (flywheel deceleration) Precession is not allowed 	Failure is detected on the motor drive inside the inverter box.	Contact Smartgyro dealer or distributor if the fault remains.	√

Anomaly message	Symptom of gyro stabilizer	Cause	Action	Alert icon flashes
“Driver Comm. Fail” “Driver Comm. Corrupt.”	<ul style="list-style-type: none"> • Motor drive disabled (flywheel deceleration) • Precession is not allowed 	Communication is not available on the CAN line between the inverter box (motor drive) and the control box.	Contact Smartgyro dealer or distributor if the fault remains.	√
“Vacuum Fail” “Vacuum Sens. Fail”	<ul style="list-style-type: none"> • Motor drive disabled (flywheel deceleration) • Precession is not allowed 	Requested vacuum level is not present in the gyro sphere (even after having tried to restore it by activating the vacuum pump), connection with the vacuum sensor is disconnected, or the value received from the vacuum sensor is invalid.	<ul style="list-style-type: none"> • Check that the connector is securely connected to the vacuum sensor on the gyro sphere. • Check that the hoses of the vacuum circuit are securely fastened to the quick connect couplings on the gyro sphere and on the vacuum pump. • Contact Smartgyro dealer or distributor if the fault remains. 	√
“RTC Fail”	Normal operation	In case an anomaly is detected in the real time circuitry inside the control box.	Contact Smartgyro dealer or distributor if the fault remains.	–
“Mainboard Temp Fail”	Normal operation	In case an anomaly temperature is detected inside the control box.	Contact Smartgyro dealer or distributor if the fault remains.	–
“CANBUS Absence” or “CANBUS Corrupted”	Normal operation (it is not possible to move to home and performance monitor pages)	Lost communication between gyro unit and control display.	<ul style="list-style-type: none"> • Check the connections of the 25-meter-long cable that links the gyro unit to the control display and of the display adapter cable. • Contact Smartgyro dealer or distributor if the fault remains. 	–
System remains in “WAIT INVERTER BOOT” or “WAIT INVERTER DATA” mode	Normal operation not possible	AC Power not connected to the gyro.	Check that AC power supply reaches the gyro.	

Specifications

Introduction

Specifications are subject to change without prior notice.

SG80 Technical characteristics

SG80 gyro unit

Maximum Rated speed	: 5500 rpm
Angular momentum at max. rated speed	: 15400 Nms
Anti - roll torque at max. rated speed	: 30100 Nm
"Spool up" time to max. rated speed	: 45 minutes
"Spool up" time to stabilization	: 25 minutes (65 % of rated speed)
Input voltage (AC)	: 208–230 V (± 10 %), 50/60 Hz, single phase
Input voltage (DC)	: 24 V
"Spool up" AC power	: 4.9 kW
Operating AC power	: 2.4–4.0 kW (sea state dependent)
DC power ("Spool up" and operating)	: 150 W (including display)
Seawater supply	: 15 (min.)–30 (max.) LPM / 4 (min.)–8 (max.) GPM
Operating temperature	: 0–60 °C (32–140 °F)
Envelope dimensions	: 1.08 x 1.11 x 0.87 m (42.4 x 43.7 x 24.3 in)
Weight	: 980 kg (2160 lbs)
Noise output	: 62–64 dBC @ 1 meter

Control display

Display type	: Touchscreen TFT LCD 5 in
Input voltage (DC)	: 10–32 V
Operating temperature	: -30–70 °C (-22–158 °F)
Dimensions	: 158 x 115 x 44 mm (6.24" x 4.53" x 37.5 x 1,73" in)



Smartgyro s.r.l.

Via Privata O.T.O. 11 - 19136 La Spezia ITALY

Phone: +39 (0) 187 1859146

www.smartgyro.com

Rev 2.0: August 2022